

VNC 100

SS-882

VF 100

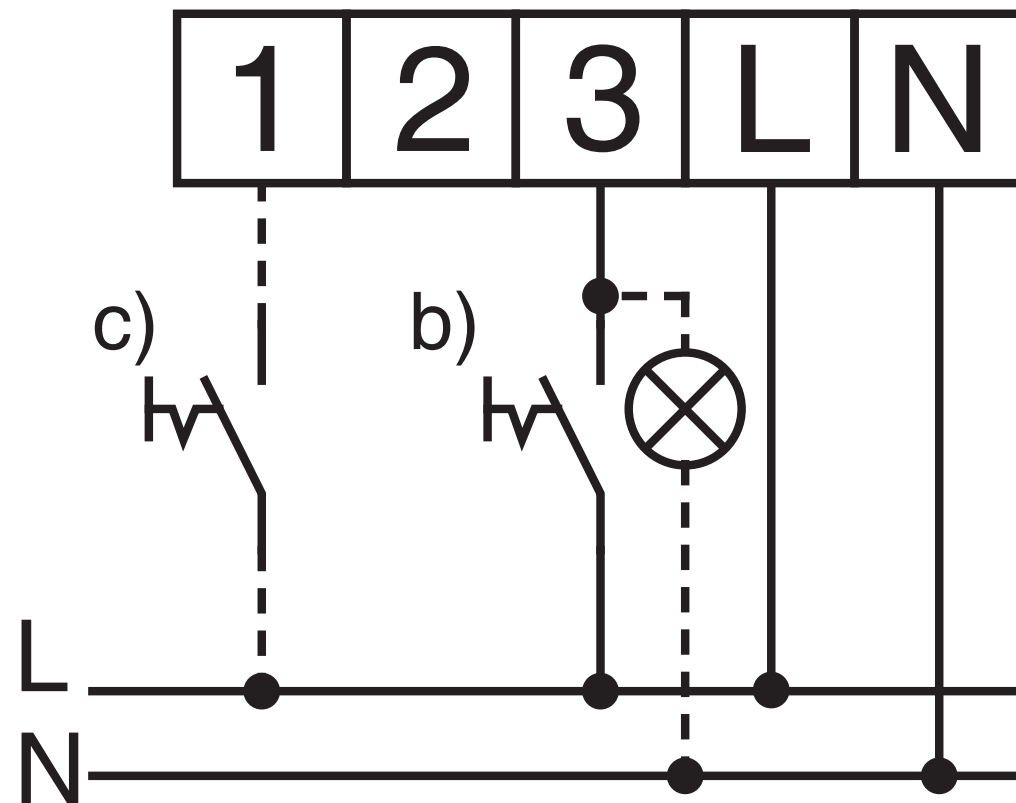

3 100 m³/h    % r.F.

b) manuálne zapnuté

c) automatika deaktivovaná